

CAMA GROUP IS A LEADING SUPPLIER OF ADVANCED TECHNOLOGY SECONDARY PACKAGING SYSTEMS, CONTINUOUSLY INVESTING IN INNOVATIVE SOLUTIONS. WHAT MAKES CAMA UNIQUE IN THE FIELD OF PACKAGING IS A “GLOBAL CONSULTING APPROACH” TO EACH CUSTOMER’S PACKAGING AUTOMATION REQUESTS.

FORMING BOX AND RSC

Cama offers great expertise and technical know-how in Forming systems technology, combining packaging machines with robotic loading systems. CAMA offers a unique range of servo driven box and case forming machines. The combination of high performance and excellent reliability results in these machines being extremely suitable for integration into complete production lines for food and non-food applications.

RANGE OF MACHINES

FA 19-24 Tray and box servo driven forming machines from cardboard, “e-flute” or corrugated blanks. Direct feed with lock-type forming or indirect feed with glue-type forming. Single, double and triple forming head.

AV 256-266 Medium and high speed RSC cases forming machinery with positive case drive. Bottom case closing with self-adhesive tape or glue.

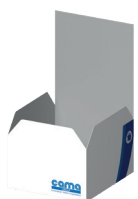

INTERNAL FLAPS

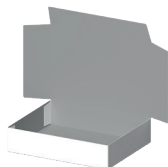

EXTERNAL FLAPS



RSC CASE

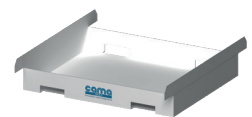

TRAY

SPECIAL FEATURES OF MACHINE

- METAL FRAME OR STAINLESS STEEL
- HIGH SPEED
- VARIOUS TYPE OF PRIMARY PRODUCT (POUCHES, FLOWPACK, THERMOFORMED ETC.)
- TYPE INDUSTRY
- LEFT AND RIGHT HAND

BREAK THROUGH GENERATION

- NO HOLLOW BODY
- MODULAR FRAME DESIGN
- NO RETENTION
- ENERGY SAVING
- ERGONOMICS
- SAFE EASY ENTRY
- SEMI AUTOMATIC CHANGE OVER

INDUSTRY

- FOOD
- BEVERAGES
- PERSONAL, HOME & HEALTH CARE
- PET FOOD

MACHINE LAYOUT

FA24

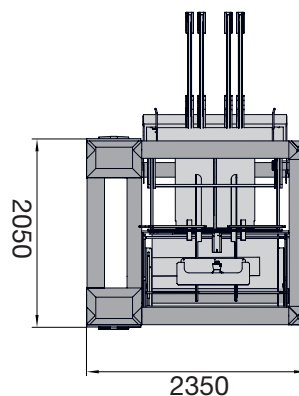

FA19

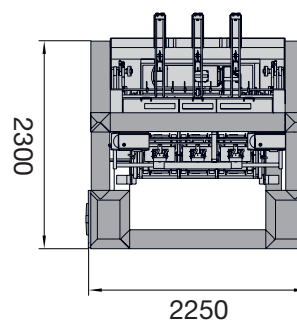

AV256

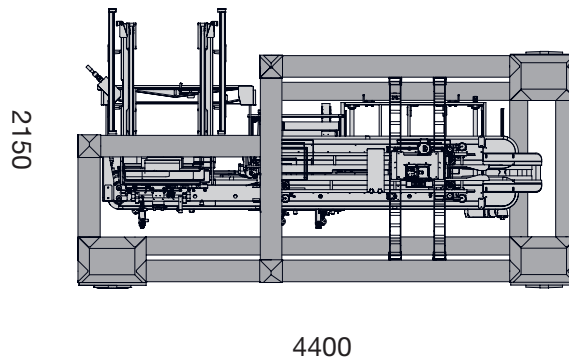

AV266

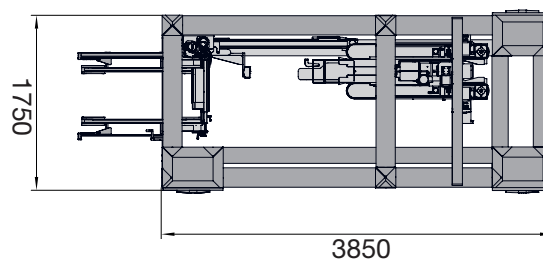

FA 19

A

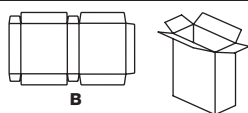

B

	SINGLE	TWIN	TRIPLE
A	575	575	575
B	980	400	300
CPM	50	100	150

FA 24

A

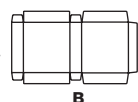

B

	SINGLE	TWIN	TRIPLE
A	675	675	675
B	1080	450	300
CPM	45	90	120

AV 256

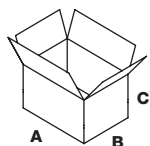

A

B

C

	SIZES (MM)		
	A	B	C
MIN	250	150	150
MAX	600	400	400
	SPEED (CPM)		
	MIN	MAX	
	-	30	

AV 266

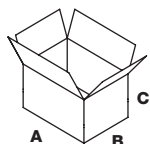

A

B

C

	SIZES (MM)		
	A	B	C
MIN	200	150	190
MAX	600	400	400
	SPEED (CPM)		
	GLUE	TAPE	
	15	15	